

EFFECT OF MACHINING TECHNOLOGY FOR DURABILITY WITH NOTCHED COMPONENTS

Michal Lattner, Jaroslava Svobodova, Radek Lattner, Pavel Kraus

J. E. Purkyne University in Usti nad Labem, Czech Republic

lattner@fvvm.ujep.cz, svobodova@fvvm.ujep.cz, lattnerr@fvvm.ujep.cz, kraus@fvvm.ujep.cz

Abstract. Nowadays, the notch problems and their influence on component durability are the issue of investigation. For many manufactured components, we find various types of notches, such as grooves, step and holes. They have a tendency to be in the place where stress is concentrated, the so called macroscopic stress concentrator. This area is a dangerous part of a component. Nowadays, there are hypotheses that are based on the assumption that the higher the roughness, the lower the durability. In many cases the designers prescribe unnecessarily high surface quality. It is necessary to maintain adequate quality of the surface, and also it is necessary that the component has attained a high durability. The paper deals with the influence of machining technology carrying capacity of notched components. As the test material steel Fe510 was used according to EN ISO (11523, according to CSN 42 0002).

Keywords: steel, machining, notch, stress, roughness.

Introduction

The paper deals with an experiment of cyclic loading steel Fe510 according to EN ISO. In many industries we can find components with grooves, holes and indentations. The greatest potential where there is a fatigue fracture is the place where there is the highest stress. This is the reason why we have to take substantial respect of their design, method of manufacture and method of machining the surface around them. Designers can never eliminate stress completely [1]. In the case below we show a possibility how to calculate the notched parts. In our experiment we just observe the influence of machining technologies.

Material Fe510 is unalloyed structural steel, from which semi-finished hot-rolled bars, hot-rolled plates and cold-drawn bars arise. It is also used in the automotive industry and thermal power plants.

Suitable use of machining technologies can mean a significant impact on the component life and the whole system [2].

Calculation of structural notches affected by production

There is one of the cases how to calculate a notched part. Structural notches are used on flat and rotary components; it is a notch type U, V, recess and other transitions of rotary or planar surfaces. In the place of the notch the stress varies in the cross section compared to the ideal (Fig. 1 and 2). For example, for the tensile load smooth flat bars with the dimensions of the cross section $B \cdot t$ (Fig. 1) we supposed ideal uniform stress in tension in all cross-sections (1). If we create a specific location V-notch occurs at the point of the smallest cross section $b \cdot t$ of the surface tension approximately saddle-shaped, where in the extreme fibers of the notch the stress is substantially higher than the intermediate stress in the notch (2), $\sigma_{\max} > \sigma$. In contrast, in central fibers lower stress arises. The stress waveform is true, of course, only if σ_{\max} is less than or equal to the yield strength of the material $\sigma_{\max} \leq R_e$ (more precisely limit proportionality $\sigma_{\max} \leq \sigma_u$). Coefficient shape α is the ratio of maximal stress in the notched part to the nominal stress in the notch (3). Values of the shape coefficient α published by Peterson [3] on the basis of the [4] include a formula for determining the coefficient of the shape α .

$$\sigma = \frac{F}{B \cdot t} \text{ (MPa)}, \quad (1)$$

where F – force, N;
 B – bar width, mm;
 t – thickness, mm.

$$\sigma_s = \frac{F}{b \cdot t} \text{ (MPa)}, \quad (2)$$

where σ_s – intermediate stress in the notch, Pa.

$$\alpha = \frac{\sigma_{max}}{\sigma_{nom}}, \tag{3}$$

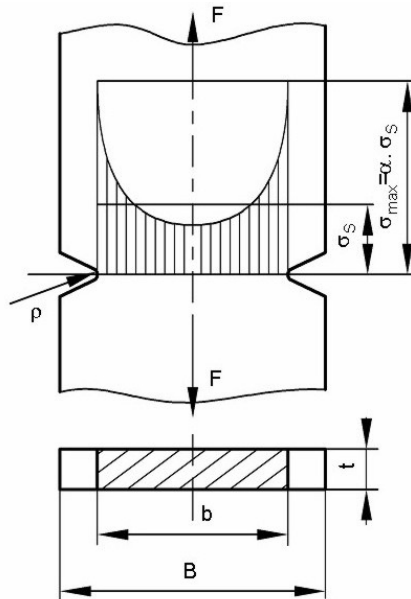

Fig. 1. Stress effect in the flat bar with tensile load $\sigma_{max} \leq R_e$

The big problem is when cyclically loaded components, the state of the surface quality and the sample size significantly affect all dynamic strength properties of materials [5]. Fatigue limit of the actual part from fatigue samples and the same of the raw material is highly variable.

If we term the fatigue limit “ideal small”, the sample like σ_c fatigue limit of components σ_c^* can be approximately expressed by the factors such as

$$\sigma_c^* = \eta_p \cdot \eta_z \cdot \eta_v \cdot \eta_x \cdot \sigma_c \text{ (MPa)}. \tag{4}$$

The coefficient η_p reflects the influence of the mechanical surface quality. It describes the fact that the majority of fractures occur in micronotches, scratches and cracks on the surface. The rougher the surface, the easier is developing of component fatigue failure. In Figure 3 there is relation η_p on the strength of the steel σ_p for various surface machining of the bar and in its corrosion.

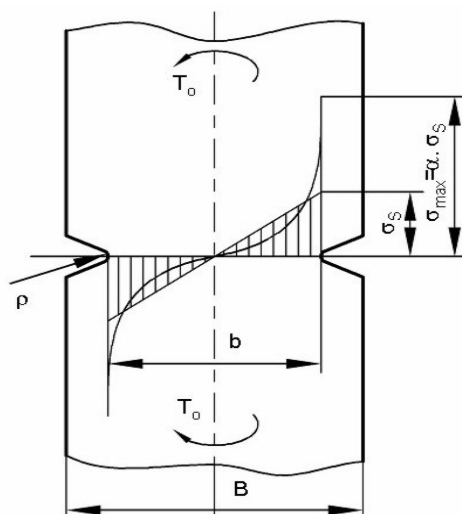

Fig. 2. Stress effect in the flat bar with bending load $\sigma_{max} \leq R_e$

The coefficient η_z captures the effect of the surface machining technology. The value must be determined experimentally. This is a modification of the surface layer forming and closing up of

microcracks, such as burnishing, shot peening, sandblasting, etc. and modification of heat, such as surface hardening, carburizing and nitriding. The coefficient η_p express the influence of the component sizes. It appears that the dimensions of the sample have the fatigue strength that plays a relatively important role. Most problematic is the determination coefficient η_x , which summarizes the effect of the shape components and technologies. Generally speaking, it decreases with the increase in the shape complexity of the part. It may deteriorate “coarse” technological processes [6], such as cold forming, welding, etc. significantly.

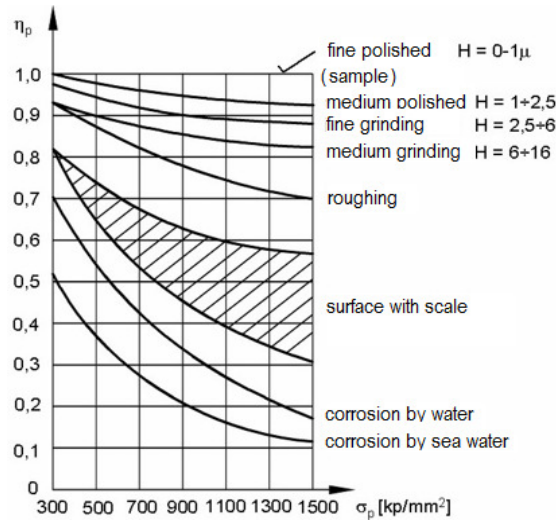

Fig. 3. Coefficient related to the quality and condition of the surface fatigue strength of the sample depending on the breaking strength of steel

The above analysis of current computational models shows that the notch is constructionally solved by its surroundings. When we specifying the right manufacturing technology we can expect material and the manufacturing savings.

Experiment

The experiment was realized in own research laboratories. The base of the experiment is to find a suitable finishing technology that would allow extending the life of components under cyclic loading. As already mentioned, the investigation material is steel Fe510.

As an abrasive for machine notch, we chose a grinding wheel of cubic boron nitride. For creating a notch further a knife was used made of high speed steel with tool radius the same as the abrasive wheel RB2 B91 W50. For creating a surface in the vicinity of notches three wheels were used: RB2 B54 W125 (CBN), which is characterized by high hardness and sharpness of edges AG 92/91 320 K 8V (microcrystalline corundum) and AG 92/91 150 K 10V [7]. Both corundums are characterized by grains with higher geometric regularity. The grain has higher removal ability, thanks to self-sharpening effects. The characteristic parameters indicate that it is a soft roll. Another tool for machining the surface was a plate with sintered carbides RCMT 0602 M0E – UR 9230. It is equipped with a special carbide MT – CVD coating [8]. These plates provide a broad application in the area for steel, cast iron and stainless steel. For the experiment the cutting fluid Diol 5 % was chosen.

After machining, the test sample is measured and clipped into a universal testing machine Hegewald & Peschke Inspect 100 kN. The machine has maximum tensile strength, pressure strength, and the bend strength is 100 kN. The program for cyclic loading has been established as a block program in the machine software. The range of values for the cyclic load was determined by the value of 630-550 MPa. Data for these values we got from the previous tensile tests. Fig. 4 shows the shape of the test specimen.

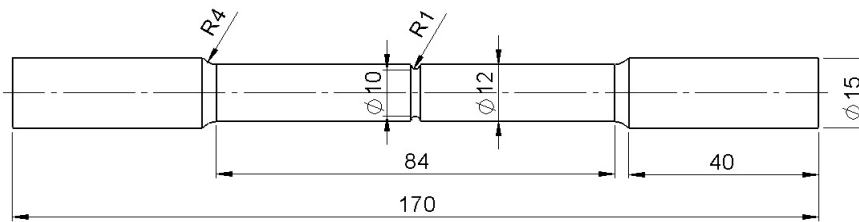

Fig. 4. Shape of testing specimen

Table 1

Experiment plan, tension 630-550 MPa, material EN ISO Fe510,
(11523, according to CSN 42 0002)

Notch machining	Cutting speed v_c	Feed speed f	Machining of surface	Cutting speed v_c	Feed speed f
B91 RB2 W50	$35 \text{ m}\cdot\text{s}^{-1}$	$0.13 \text{ mm}\cdot\text{min}^{-1}$	AG 92/99 320 K 8V	$40 \text{ m}\cdot\text{s}^{-1}$	$0.1 \text{ m}\cdot\text{min}^{-1}$
			AG 92/99 150 K 10V	$40 \text{ m}\cdot\text{s}^{-1}$	$0.1 \text{ m}\cdot\text{min}^{-1}$
			B54 RB2 W125	$40 \text{ m}\cdot\text{s}^{-1}$	$0.1 \text{ m}\cdot\text{min}^{-1}$
			SC- RCMT	$94 \text{ m}\cdot\text{min}^{-1}$	$0.05 \text{ mm}\cdot\text{rev}^{-1}$
Turning HSS (R1)	$50 \text{ m}\cdot\text{min}^{-1}$	$0.05 \text{ mm}\cdot\text{rev}^{-1}$	AG 92/99 320 K 8V	$40 \text{ m}\cdot\text{s}^{-1}$	$0.1 \text{ m}\cdot\text{min}^{-1}$
			AG 92/99 150 K 10V	$40 \text{ m}\cdot\text{s}^{-1}$	$0.1 \text{ m}\cdot\text{min}^{-1}$
			B54 RB2 W125	$40 \text{ m}\cdot\text{s}^{-1}$	$0.1 \text{ m}\cdot\text{min}^{-1}$
			SC- RCMT	$94 \text{ m}\cdot\text{min}^{-1}$	$0.05 \text{ mm}\cdot\text{rev}^{-1}$

Roughness measurement and cyclic loading

Data for this experiment were obtained from the Faculty of Production Technology and Management in the laboratory of precision measurements and mechanical testing laboratory.

The sample was seated in the prism holder and the roughness was measured by the tester Hommel T8000 according to CSN EN ISO 4287. In the experiment, we used several specific parameters, namely R_a , R_z and R_t . The observed point was the bottom of the notch and the notch. In Fig. 5 an universal testing machine can be seen for cyclic loading and recording diagrams.

For realization of cyclic stress loading a range was chosen depending on the material range from 630 to 550 MPa. The value is 630 MPa absolute upper limit to which the sample is loaded and the value of 550 MPa is absolute lower limit at which the load decreases. The loading is used by the maximum increase and decrease of the stress $20 \text{ MPa}\cdot\text{s}^{-1}$ and the cycle period $T = 8\text{ s}$. Speed of stress is defined by the CSN EN ISO 6892-1.

Fig. 6 shows a different durability of samples under cyclic load. The first part of the sample name is the method that was created by a notch (CBN – abrasive wheel RB2 B91 W50, HSS – high speed steel tool), the second part is a method, by which the notch vicinity is machined (SG320, SG150 – microcrystalline corundum, CBN – B54 RB2 W125 and SC – sintered carbide). The graph shows some interesting facts. We can assume that the use of the finishing technology can extend the life of components, but it may not be the rule. In our case, the maximum number of cycles occurred in the sample, in the area where the notch was machined using sintered carbide.

The case of Fig. 7 points out the fact that application of the finishing technology in the form of a microcrystalline corundum significantly influences the life of the components, respectively durability of the sample.

Complex graph on Fig. 8 shows the dependence between the surface roughness R_a and the component life. The numbers in the boxes represent the number of cycles to fracture. Some experiments were repeated for results verification. The results were very close.

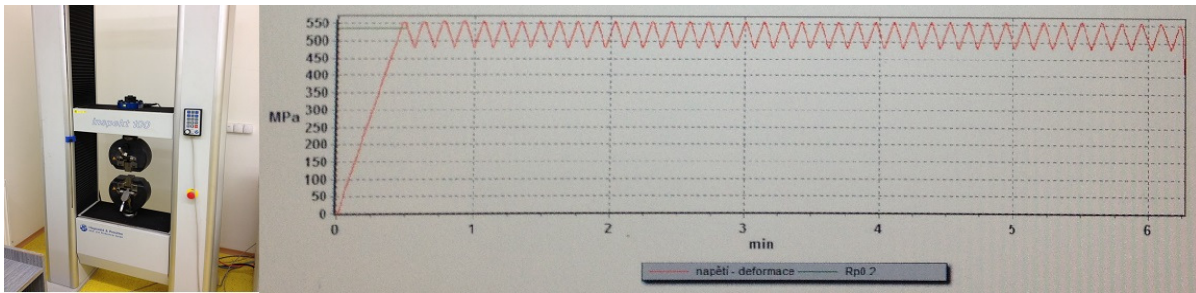

Fig. 5. Universal machine Inspekt 100 kN and record diagram of cyclic load

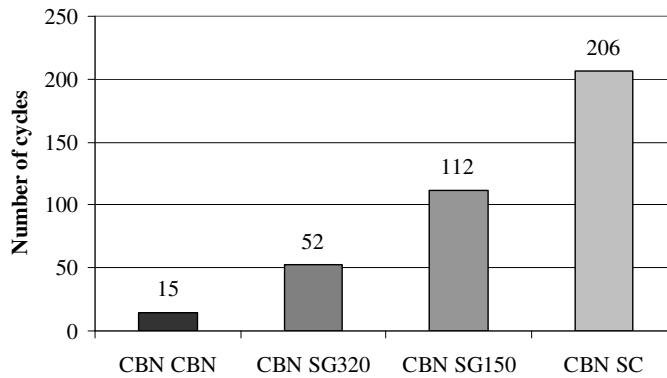

Fig. 6. Relation between number of cycles and notch creation by B91 RB2 W50

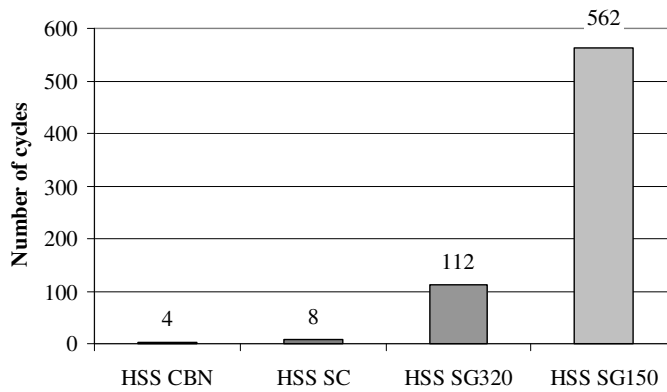

Fig. 7. Relation between number of cycles and notch creation by HSS

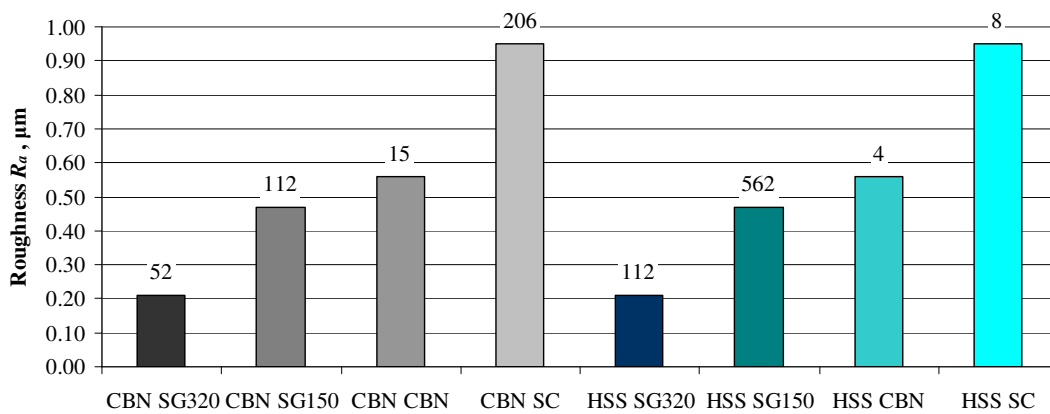

Fig. 8. Relation between roughness R_a and cycle number

Conclusions

1. The case, where the notch was created by cubic boron nitride, has demonstrated favourable influence of machining using sintered carbide. In addition, you can see the positive influence of microcrystalline corundum.
2. In the case, where the notch was created by blades from high speed steel, the most appropriate technology for machining of the surface was shown by microcrystalline corundum grinding.
3. Vice versa, machining by sintered carbide had the worst impact.
4. If we compare the effect of roughness for durability components, so in the notch created by HSS it is possible to see positive impact of the finishing technologies and with lower surrounding surface roughness the sample reaches a higher number of cycles.
5. In notch grinding by cubic boron nitride it is also possible to see the influence of the finishing technology, but the machined surface of sintered carbide points out the fact that it is necessary to examine this issue more deeply.

References

1. Sadeler R., Ozel A., Kaymaz I., Totik Y. The Effect of Residual Stresses Induced by Prestraining on Fatigue Life of Notched Specimens, JMEP, vol. 14, ISSN 1059-9495, 2005, 351 p.
2. Holešovský F., Hrala M., Zelenková J. Ground Surface – Formation and Changes at Dynamical Loading. Manufacturing Engineering, ISSN 1335-7972, 2006, pp. 13-17.
3. Pilkey D.W., Pilkey F.D. Peterson's Stress Concentration Factors, 3rd edition, Inc. United States ISBN: 978-0-470-04824-5.
4. Novák M., Hiroshi K., Ohmori H. Differences at the Surface Roughness by the ELID and Grinding Technology. Manufacturing Technology, vol. 13, no. 2, 2013, UJEP, Ústí nad Labem pp. 210-215, ISSN 1213-2489.
5. Warren C.Y., Budynas R.G. Roark's Formulas for Stress and Strain. 7. vyd. New York: McGraw-Hill, ISBN 0-07-072542-X, 2002.
6. Holesovský F., Novak M., Lattner M. Influence of Machining Process on Design Notch Performance. Precision machining VI, Key Engineering Materials - Trans Tech Publications Inc., UK, vol. 496, ISBN 978-3-03785-297-2, 2012, 217 p.
7. Svobodová J., Kraus P., Müller M., Lebedev A., Yurov A., Lebedev P. Influence of Cutting Fluid on Abrasive – free Ultrasonic Finishing of Aluminium Alloy, Manufacturing Technology, 2015, ISSN 1213-2489.
8. Svobodova J., Kraus P., Cais J., Lattner R.: Research of Chemical Pre-treatment Created by Sol-gel Process on the Polished Surface of Aluminium Substrate, Manufacturing Technology, Journal for Science, Research and Production, February 2016, vol. 16(1), pp. 4-12, ISSN 1213-2489.