

## MODEL OF HYDROPNEUMATIC THREE POINT HITCH

**Janis Laceklis-Bertmanis, Eriks Kronbergs**  
Latvia University of Agriculture  
janis.laceklis@llu.lv, eriks.kronbergs@llu.lv

**Abstract.** This paper presents a model of a hydropneumatic three point hitch system for farm tractors. A model of hydropneumatic three point hitch is derived to suit the control task of oscillations damping of the tractor aggregate. The reaction forces of the tractor hitch system hydraulic cylinder were determined, corresponding to different weight positions of the implement. The hitch mechanism is divided in three kinematic groups (unit of upper link and implement, unit of lift arm and unit of lower link) for calculations. From the simulation with the program Working Model it was established that the tractor hitch system lower link and mounted soil cultivation tool at low amplitude oscillations during transport can be simplified as a single beam. The necessary stiffness characteristics for beam suspension, depending on the implement weight and its position, were determined. Uses of hydraulic accumulators were provided for obtaining different stiffness characteristics of suspension. The volume and necessary charge pressure were determined for hydraulic accumulators.

**Keywords:** hydropneumatic hitch, hydraulic accumulators.

### Introduction

During tractor movement, with attached to the hitch-system working equipment (plough, harrow), over rough road surfaces oscillation of the machine takes place. These oscillations are a reason of pressure pulsations in the hydraulic hitch-system.

The previous experiment [1] presents results of pressure oscillation investigation in the hydraulic hitch-system of the tractor Claas Ares ATX 557 during the motion around an artificial roughness test road. During the experiments oscillations at the different driving speed, different tire pressure, loading weight position and hitch-system oscillation damping (turned on/off) were investigated. The results of the experiments present maximum pressure peaks of 170 bar in the tractor hydraulic system.

The hydraulic hitch-system with hydropneumatic accumulators allows adjusting the stiffness and damping characteristics of the hydraulic cylinder, limiting the pressure oscillation amplitude. In order to reduce the pressure maximal values during oscillations, a mathematical model of tractor hydraulic hitch system with hydropneumatic accumulators was developed. The mathematical model for the implement on the hitch system was simplified to the model of a single beam with different weight and moment of inertia. The results of calculations were compared with the results of the experiments.

### Materials and methods

The three-point hitch mechanism was considered as a planar system. The system was modelled in two dimensions to represent the force in the original geometrical configuration between the tractor and the implement. In order to evaluate the vertical force of tillage tools a two dimensional study of tractor linkage mechanism is needed. The mechanisms consist of seven articulated beams. To make the force calculation simpler, the three-point hitch-system mechanism was described by ties and pin joints. The coordinates of each joint are calculated in a coordinate system and the three-point hitch mechanism is shown in (Fig. 1). The Working Model software [2] for the tractor three point hitch-system small amplitude oscillation simulations was used.

In the Working Model software dynamic model with the same parameters of the tractor and attached equipment weight, road roughness and movement speed as in the experimental investigation had been used [3]. The simulation model in the previous experiment is expressed in the side-view.

This side view of the three-point hitch mechanism model was created and described on transportation position. The implement displacement and oscillations are depending on the tractor driving speed, road roughness and tractor hitch-system stiffness, and damping parameters. The tractor hitch-system actuator consists of two hydraulic cylinders and it was used for mounted implement lift up or down. The parameters of the hydraulic cylinder and tyres are doubled in the side-view simulation model.

From the simulation with the program Working Model it was established that the tractor hitch system lower link and mounted soil cultivation tool at low amplitude oscillations can be simplified as

a single beam. To determine the hydraulic cylinder arm for a single beam simplified hitch-system it is necessary to calculate the equilibrium of a common hitch-system mechanism.

**Results and discussion**

For calculation the hitch mechanism is divided in three kinematic groups:

- unit of upper link and implement,
- unit of lift arm;
- unit of lower link.

The common hydraulic hitch-system mechanism and loading aggregate kinematic scheme are shown in (Fig. 1).

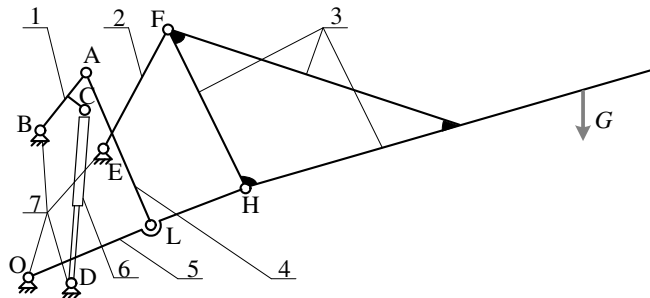

Fig. 1. **Side view of three-point hitch mechanism:** 1 – lift arm (changeable); 2 – upper link (changeable); 3 – simplified implement; 4 – lift rod; 5 – lower link; 6 – tractor hydraulic hitch-system hydraulic cylinder; 7 – support.

As the first the upper link and the implement unit are described. The implement was described on transportation position (Fig. 2).

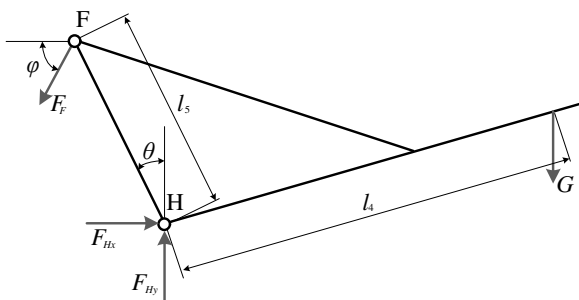

Fig. 2. **Unit of upper link and implement**

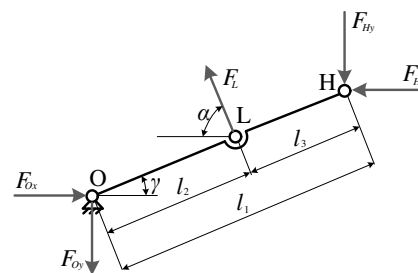

Fig. 3. **Hitch-system lower link unit**

The projections of forces and moment of the unit of the upper link and implement give the following system of equations:

$$\sum y_i = 0; F_F \cdot \sin \varphi + F_{Hy} - G = 0 \tag{1}$$

$$\sum x_i = 0; F_F \cdot \cos \varphi + F_{Hx} = 0 \tag{2}$$

$$\sum M_H = 0; F_F \cdot \cos \varphi \cdot l_4 \cdot \cos \theta + F_F \cdot \sin \varphi \cdot l_5 \cdot \sin \theta - G \cdot l_4 \cdot \cos \theta = 0 \tag{3}$$

The  $F_F$ ,  $F_{Hx}$  and  $F_{Hy}$  are the lift rod reaction forces at the point  $F$  and  $H$ , but  $G$  is the weight of the implement. These values depend on the tractor hydraulic hitch-system position.

The lower link unit is described as the second. The lower link one side is connected to the tractor frame, but another side is connected with the implement lower support (Fig. 3).

The projections of forces and moment of the lower link give the following system of equations:

$$\sum y_i = 0; -F_{Oy} + \sin \gamma - F_{Hy} = 0, \tag{4}$$

$$\sum x_i = 0; -F_{Ox} - F_L \cdot \cos \alpha - F_{Hx} = 0, \tag{5}$$

$$\sum M_O = 0; F_L \cdot \sin \alpha \cdot l_2 \cdot \cos \gamma + F_L \cdot \cos \alpha \cdot l_2 \cdot \sin \gamma - F_{Hy} \cdot l_1 \cdot \cos \gamma + F_{Hx} \cdot l_1 \cdot \sin \gamma = 0 \quad (6)$$

where  $F_{Ox}$  and  $F_{Oy}$  is the reaction force at the point  $O$ , but  $F_L$  is the reaction at the point  $L$ . The values of angles depend on the tractor hitch-system hydraulic cylinder position.

The lift arm unit is described as the last. One side of the lift arm is connected to the tractor frame with the pivot  $B$ , but another side is connected with the lift rod (Fig. 4). The position of the lift arm is changed by the hydraulic cylinder. The hitch-system lifting arm unit is located in the transport position when the hydraulic cylinder is at stretched position.

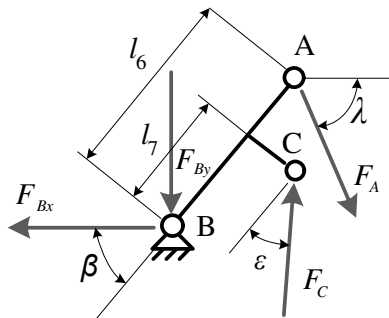

Fig. 4. Hitch-system mechanism unit

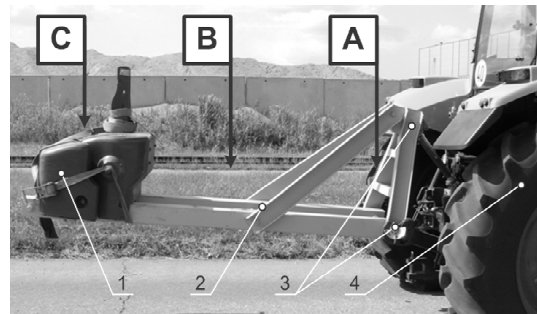

Fig. 5. Physical implement and weight position on three point hitch-system of tractor: 1 – weight; 2 – physical implement; 3 – three point hydraulic hitch-system; 4 – tractor *Claas Ares 557 ATX*; A, B and C – position of weight

The projections of forces and moment of the unit of the upper link and implement give the following system of equations:

$$\sum y_i = 0; -F_{By} - F_A \cdot \sin \lambda + F_C \cdot \sin \epsilon = 0 \quad (7)$$

$$\sum x_i = 0; -F_{Bx} + F_A \cdot \cos \lambda - F_C \cdot \cos \epsilon = 0 \quad (8)$$

$$\sum M_B = 0; F_C \cdot \sin \epsilon \cdot l_7 \cdot \cos \beta + F_C \cdot \cos \epsilon \cdot l_7 \cdot \sin \beta + F_A \cdot \sin \lambda \cdot l_6 \cdot \cos \beta + F_A \cdot \cos \lambda \cdot l_6 \cdot \sin \beta = 0 \quad (9)$$

where  $F_{Bx}$  and  $F_{By}$  is the reaction force at the point  $B$ , but  $F_C$  is the reaction of the hydraulic cylinder at the point  $C$ .  $F_C = F_D$  are the reactions of the lift arm at the points  $C$  and  $D$ . The values of the angles depend on the tractor hitch-system hydraulic cylinder position.

The force reaction of the tractor hydraulic hitch-system cylinder was calculated from the equilibrium equation. The pressure values in the hydraulic cylinder if the friction is neglected can be calculated by the following expression:

$$p = \frac{F_c}{A} \quad (10)$$

where  $p$  – hydraulic cylinder pressure in chamber, Pa;  
 $F_c$  – force of hydraulic cylinder, N;  
 $A$  – piston area of hydraulic cylinder, m<sup>2</sup>.

The previous experiment [1] presents the results of pressure in the hydraulic hitch-system of the tractor Claas Ares ATX 557 if the loading weight (Fig. 5) is situated on the positions A, B, C and fixed on transportation position. At position A the initial average pressure is 50 bar but at position B it reaches till 110 bar and at position C till 145 bar.

Putting the force reactions  $F_{CA}$ ,  $F_{CB}$  and  $F_{CC}$  in to the equation (10) at position A the initial pressure is 46.7 bar but at position B it reaches till 109.7 bar and at position C till 156.9 bar were calculated.

For creating of a simplified model of the hitch system and mounted implement (Fig. 6) it is necessary to determine the coordinate of the hydraulic cylinder  $l_9$  at different weight positions (A, B and C) on condition if  $F_L = F_A$ , (Fig. 3, 4) then:

$$l_9 = \frac{G \cdot l_8}{F_N} \tag{11}$$

where  $l_8$  – coordinate of loading weight, m.

The calculated  $l_9$  for position A of the hydraulic cylinder coordinate is 0.29 m but for position B it reaches 0.31 m and for position C it is 0.33 m. In further calculations the average hydraulic cylinder coordinate ( $l_9 = 0.31$  m) was used. In order to study the dynamic oscillation of the tractor hydraulic hitch-system in the experiments an artificial roughness test road was used. Changing the driving speed from  $3 \text{ km} \cdot \text{h}^{-1}$  till  $13.7 \text{ km} \cdot \text{h}^{-1}$  the forced oscillation frequency changes from 2.65 Hz to 11.95 Hz.

The results of the experiments have shown that the resonance of oscillations occurs at the driving speed  $7.8 \text{ km} \cdot \text{h}^{-1}$  and the forced oscillation angular frequency is 6.81 Hz.

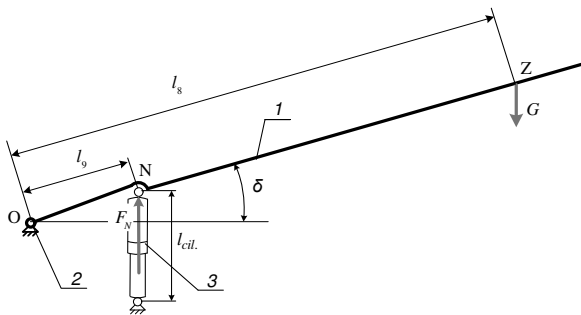

Fig. 6. Simplified side view of three-point hitch mechanism: 1 – simplified lifting lever; 2 – support; 3 – hydraulic cylinder

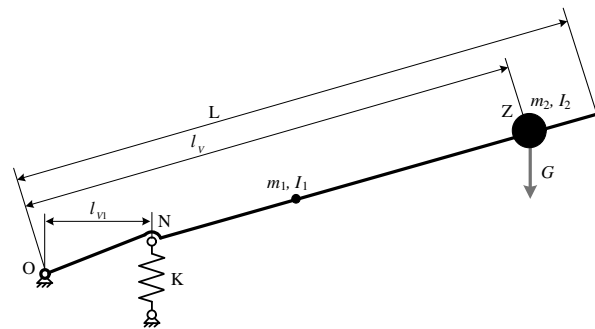

Fig. 8. Simplified side view model of fiscal three-point hitch mechanism

Assuming that the tractor is equipped with a tillage tool, the average transport speed ranges from  $10 \text{ km} \cdot \text{h}^{-1}$  to  $15 \text{ km} \cdot \text{h}^{-1}$ . If the tractor is moving through the road surface roughness  $0.05 \text{ m}$  - the angular frequency will range from 8.73 Hz to 13.9 Hz.

The free oscillation frequency of the implement against the tractor frame should be at least four times less than the forced oscillation frequency, then the mounted tillage tools could be used [4] as oscillation suppressors. Then the physical model (Fig. 6) of the free oscillation frequency will be 2.18 to 3.27 Hz, expressed in the formula:

$$\lambda = \sqrt{\frac{l_{V1}^2 \cdot k}{I_{\Sigma}}}, \tag{12}$$

where  $l_{V1}$  – distance to hydraulic cylinder, m;  
 $I_{\Sigma}$  – summary loading tool moment of inertia,  $\text{kg} \cdot \text{m}^2$ ;  
 $k$  – hydraulic cylinder stiffness coefficient,  $\text{N} \cdot \text{m}^{-1}$ .

Assuming that the physical model of the free oscillation frequency is 3 Hz, then from the equation (12) we can find the three-point system hydraulic cylinder stiffness coefficient  $k$  at different loading weight positions (A, B and C):

$$k = \frac{\lambda^2 \cdot I_{\Sigma}}{l_{V1}^2}, \tag{13}$$

The overall inertia moment of the physical model at certain weight positions (A, B and C) is obtained ( $I_A = 1372.14 \text{ kg} \cdot \text{m}^2$ ,  $I_B = 6714.54 \text{ kg} \cdot \text{m}^2$ ,  $I_C = 12059.92 \text{ kg} \cdot \text{m}^2$ ). The overall system spring stiffness coefficient value at certain weight position is ( $k_A = 149622.92 \text{ N} \cdot \text{m}^{-1}$ ,  $k_B = 631365.31 \text{ N} \cdot \text{m}^{-1}$ ,  $k_C = 1113376 \text{ N} \cdot \text{m}^{-1}$ ). Knowing the static pressure  $p_1$  of the tractor hydraulic system, when the

hydraulic hitch loading tool is at transport position and the pressure peak values during transport  $p_2$ , then displacement of the hydraulic cylinder is expressed with the following equation:

$$x = \frac{(p_2 - p_1) \cdot A}{k}, \tag{14}$$

where  $p_1$  – average pressure at static mode, Pa;  
 $p_2$  – pressure maximum value at transport mode, Pa;  
 $A$  – cross-sectional area of hydraulic cylinder,  $m^2$ .

Significant pressure changes in the hydraulic hitch system (without accumulators) occurred when the loading weight was placed in positions  $B$  (145-175 bar) and  $C$  (180-220 bar), but if the weight was placed at position  $A$ , the pressure values were in the range of 75-95 bar, which does not significantly affect the handling of the tractor aggregate and the hydraulic system lifetime. For further calculations the pressure values at the weight adjustment  $B$  and  $C$  are used. Then the tractor hydraulic cylinder rod displacement of the reduced stiffness will be  $x_B = 0.028$  m,  $x_C = 0.012$  m if the static pressure of the tractor hydraulic hitch system  $p_{1B} = 130$  bar and  $p_{1C} = 145$  bar, but the pressure to which the hydraulic systems are designed to limit  $p_{2B} = 150$  bar and  $p_{2C} = 160$  bar.

Then the volume changes of the tractor hydraulic system at weight position  $B$  ( $\Delta V_B = 0.25 \cdot 10^{-3} m^4$ ) and  $C$  ( $\Delta V_C = 0.11 \cdot 10^{-3} m^4$ ) are expressed as the equation:

$$\Delta V = x \cdot A \tag{15}$$

From the calculations the required number of hydraulic accumulators was determined at their fixed constructive volume, the hydraulic accumulators adiabatic volume change graph was used (Fig. 9).

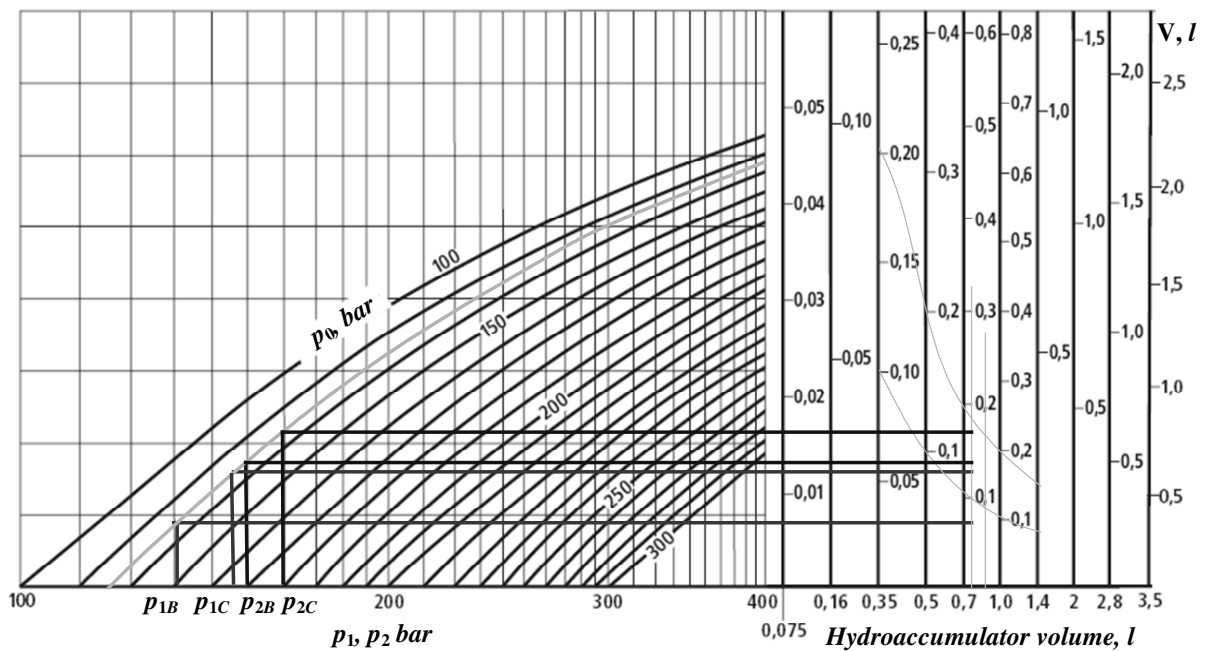

Fig. 9. Adiabatic characteristics volume changes of hydraulic accumulators

The diagram shows that at the hydraulic accumulator constructive volume 0.75 l and the loading weight at position  $B$ , where  $p_{1B} = 130$  bar, but  $p_{2B} = 150$  bar, the average volume changes are  $\Delta V \approx 0.076$  l, but if the loading weight is at position  $C$ , where  $p_{1C} = 145$  bar, but  $p_{2C} = 160$  bar, the average volume changes are  $\Delta V \approx 0.038$  l. As a result, to ensure that equation (15), the calculated volume change would require three hydraulic accumulators which were loaded in to 130 bar. If there is extreme roughness of the road hydraulic accumulators would be loaded at higher pressure, such as 150 bar.

## Conclusions

1. The free oscillation frequency of the implement against the tractor frame should be at least four times less than the forced oscillation frequency, then the mounted tillage tools could be used as oscillation suppressors.
2. Knowing the static pressure of the tractor hydraulic system, when the hydraulic hitch loading tool is at transport position and the permissible pressure peak values during transport, the displacement and stiffness of the hydraulic cylinder can be determined.
3. Corresponding to the stiffness of the hydraulic cylinder the required number of hydraulic accumulators at their fixed constructive volume and charging pressure is determined using adiabatic volume changes graphs.

## Acknowledgement

Paper was written by financial support of European Structural Fund – Support for Realization of Doctoral Studies in Latvia University of Agriculture - realized by Project Department of Latvia University of Agriculture (contract no. 2009/0180/1DP/1.1.2.1.2/09/IPIA/VIAA/017).

## References

1. Laceklis-Bertmanis J., Pirs V., Kronbergs E., Metla-Rozentals A., Metla M. Physical model of tractor implement. In: Proceeding of the 18<sup>th</sup> International Scientific Conference „Research for Rural Development”. Jelgava: LUA, 2012, pp. 217-222.
2. MSC.Software Corporation. Working Model 2D software, User’s Manual (2000).
3. Laceklis-Bertmanis J., Pirs V., Jesko Z. Investigation of Pressure Oscillation in Hydraulic Hitch-System. In: Proceedings of the 16th International Scientific Conference “Research for Rural Development”. Jelgava: LUA, 2010.
4. Николаи Е.Л. Теоретическая механика, часть II. Государственное издательство технико-теоретической литературы, Москва, 1960. 484 с.